

250mA SmartOR™ Regulator with V_{AUX} Switch

Features

- Automatic detection of V_{CC} input supply
- Glitch-free output during supply transitions
- Built-in hysteresis during supply selection
- 250mA output maximum load current
- Fully integrated V_{AUX} switch
- Overload current protection
- Short circuit current protection
- Operates from either V_{CC} or V_{AUX}
- 8-pin SOIC package
- RoHS compliant (lead-free) finishing

Applications

- PCI adapter cards
- Network Interface Cards (NICs)
- Dual power systems
- Systems with standby capabilities

Product Description

The California Micro Devices' SmartOR™ CMPWR101 is a low dropout regulator that delivers up to 250mA of load current at a fixed 3.3V output. An internal threshold level (typically 4.1V) is used to prevent the regulator from being operated below dropout voltage. The device continuously monitors the input supply and will automatically disable the regulator when V_{CC} falls below the threshold level. When the regulator is disabled, a low impedance, fully integrated switch is enabled which allows the output to be directly powered from an auxiliary 3.3V supply.

When V_{CC} is restored to a level above the select threshold, the low impedance switch is disabled and the regulator is once again enabled.

All the necessary control circuitry needed to provide a smooth and automatic transition between the supplies has been incorporated. This allows V_{CC} to be dynamically switched without loss of output voltage.

An output logic signal, DRIVE, is active LOW whenever the internal regulator is disabled.

The CMPWR101 is housed in a 8-pin SOIC package and is available with RoHS compliant lead-free finishing.

Typical Application Circuit

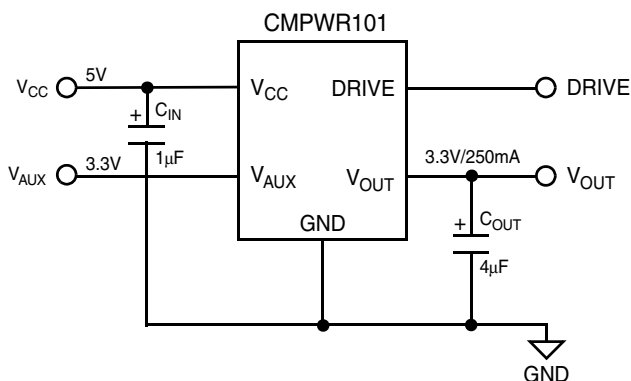

Simplified Electrical Schematic

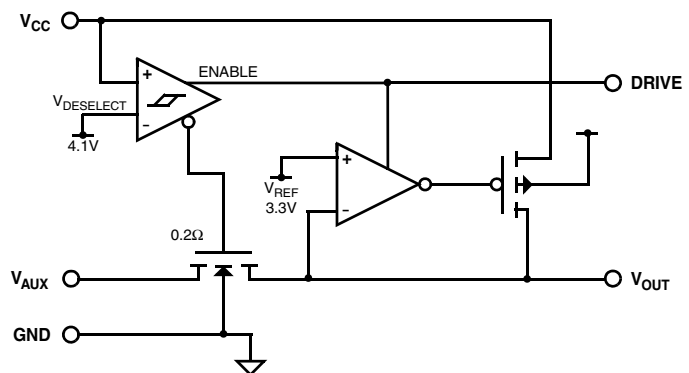

PACKAGE / PINOUT DIAGRAM

TOP VIEW

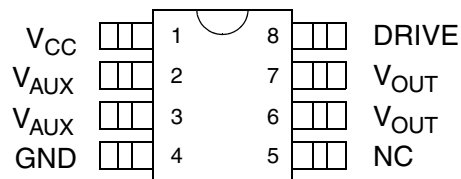

8-pin SOIC

Note: This drawing is not to scale.

PIN DESCRIPTIONS

PIN(S)	NAME	DESCRIPTION
1	V _{CC}	<p>V_{CC} is the power source for the internal regulator and is monitored continuously by an internal controller circuit. Whenever V_{CC} exceeds V_{CCSEL} (4.25V typically), the internal regulator will be enabled and deliver a fixed 3.3V at V_{OUT}.</p> <p>When V_{CC} falls below V_{CCDES} (4.10V typically), the regulator will be disabled. Internal loading on this pin is typically 0.6mA when the regulator is enabled, which reduces to 0.1mA whenever the regulator is disabled. If V_{CC} falls below the voltage on the V_{AUX} pin, the V_{CC} loading will further reduce to only a few microamperes. During a V_{CC} power-up or power-down sequence, there will be an effective step increase in V_{CC} line current when the regulator is enabled/disabled. This line current transient will cause a voltage disturbance at the V_{CC} pin. The magnitude of the disturbance will be directly proportional to the effective power supply source impedance being delivered to the V_{CC} input.</p> <p>A built-in hysteresis voltage of 150mV has been incorporated to minimize any chatter during supply changeover. It is recommended that the power supply connected to the V_{CC} input should have a source resistance of less than 0.25Ω to minimize the event of chatter during the enabling/disabling of the regulator.</p> <p>If the V_{CC} pin is within a few inches of the main input filter, a capacitor may not be necessary. Otherwise an input filter capacitor in the range of 1μF to 10μF will help to lower the effective source impedance.</p>
2 - 3	V _{AUX}	<p>V_{AUX} is the auxiliary power source. When selected, (V_{CC} < V_{CCDES}), the auxiliary supply is directly connected to V_{OUT}, via the low impedance (0.3Ω typically) fully integrated switch.</p> <p>The internal loading on this pin is typically less than 10μA and will increase to 100μA if V_{CC} falls below the voltage on V_{AUX}.</p> <p>When V_{AUX} = 0V, the V_{CCDES} voltage is inhibited which prevents the regulator from being disabled.</p>
4	GND	<p>GND is the negative reference for all voltages. The current that flows in the ground connection is very low (typically 0.6mA) and has minimal variation over all load conditions.</p>
5	NC	<p>NC is an unconnected pin which is electrically isolated from the internal circuitry</p>
6 - 7	V _{OUT}	<p>V_{OUT} is the regulator output voltage connection used to power the load. An output capacitor of 4.7μF is used to provide the necessary phase compensation, thereby preventing oscillation. The capacitor also helps to minimize the peak output disturbance during power supply changeover.</p>
8	DRIVE	<p>DRIVE is a CMOS output logic signal (Active Low) referenced to the V_{CC} supply. This output is taken low whenever the internal regulator is not enabled. This output is intended only as a control signal for external circuitry.</p>

Ordering Information

PART NUMBERING INFORMATION			
Pins	Package	Ordering Part Number ¹	Part Marking
8	Power SOIC	CMPWR101R	CMPWR 101R

Note 1: Parts are shipped in Tape & Reel form unless otherwise specified.

Specifications

ABSOLUTE MAXIMUM RATINGS		
PARAMETER	RATING	UNITS
ESD Protection (HBM)	± 2000	V
Pin Input Voltages		
V _{CC}	[GND - 0.5] to +6.0	V
V _{AUX}	[GND - 0.5] to +4.0	V
DRIVE	[GND - 0.5] to [V _{CC} + 0.5]	
Storage Temperature Range	-40 to +150	°C
Operating Temperature Range		
Ambient	0 to +70	°C
Junction	0 to +125	°C
Power Dissipation (See Note 1)	0.5	W

Note 1: The power rating is based on a printed circuit board heat spreading capability equivalent to 2 square inches of copper connected to the GND pins. Typical multi-layer boards using power plane construction will provide this heat spreading ability without the need for additional dedicated copper area. (Please consult with factory for thermal evaluation assistance).

STANDARD OPERATING CONDITIONS		
PARAMETER	VALUE	UNITS
V _{CC}	5.0 \pm 0.5	V
V _{AUX}	3.3 \pm 0.3	V
Ambient Operating Temperature Range	0 to +70	°C
Load Current	0 to 250	mA
C _{EXT}	4.7 \pm 20%	μ F

ELECTRICAL OPERATING CHARACTERISTICS (SEE NOTE 1)

SYMBOL	PARAMETER	CONDITIONS	MIN	TYP	MAX	UNITS
V _{OUT}	Regulator Output Voltage	0mA < I _{LOAD} < 250mA	3.135	3.300	3.465	V
I _{LIM}	Regulator Current Limit		275			mA
V _{CCSEL}	V _{CC} Select Voltage	Regulator enabled		4.30	4.45	V
V _{CCDES}	V _{CC} Deselect Voltage	Regulator disabled	3.90	4.10		V
V _{CCHYST}	Hysteresis Voltage	See Note 2		0.20		V
V _{R LOAD}	Load Regulation	V _{CC} =5V, 5mA ≤ I _{LOAD} ≤ 250mA		20		mV
V _{R LINE}	Line Regulation	I _{LOAD} = 5mA; 4.5V ≤ V _{CC} ≤ to 5.5V		2		mV
R _{SW}	V _{AUX} Switch Resistance	V _{CCDES} > V _{CC} , V _{AUX} = 3.3V		0.25	0.40	Ω
I _{RCC}	V _{CC} Reverse Leakage	V _{AUX} = 3.3V, V _{CC} = 0V		2	50	μA
I _{RAUX}	V _{AUX} Reverse Leakage	V _{AUX} = 0V, V _{CC} = 5V		2	50	μA
I _{GND}	Ground Current	V _{CC} < V _{CCDES} , I _{LOAD} = 0mA V _{CC} > V _{CCSEL} , I _{LOAD} = 0mA V _{CC} > V _{CCSEL} , I _{LOAD} = 250mA		0.20 0.60 0.70	0.40 1.00 1.20	mA mA mA
I _{AUX}	V _{AUX} Supply Current	V _{AUX} > V _{CC} V _{CC} > V _{AUX}		0.20 0.02	0.40 0.10	mA mA
R _{OH}	DRIVE Pull-up Resistance	R _{PULLUP} to V _{CC} , V _{CC} > V _{CCSEL}		4.0	8.0	kΩ
R _{OL}	DRIVE Pull-down Resistance	R _{PULLDOWN} to GND, V _{CCDES} > V _{CC}		0.1	0.4	kΩ

Note 1: Operating Characteristics are over Standard Operating Conditions unless otherwise specified.

Note 2: The hysteresis defines the maximum level of acceptable disturbance on V_{CC} during switching. It is recommended that the V_{CC} source impedance be kept below 0.25Ω to ensure the switching disturbance remains below the hysteresis during select/deselect transitions. An input capacitor may be required to help minimize the switching transient.

Performance Information

CMPWR101 Typical DC Characteristics (nominal conditions unless specified otherwise)

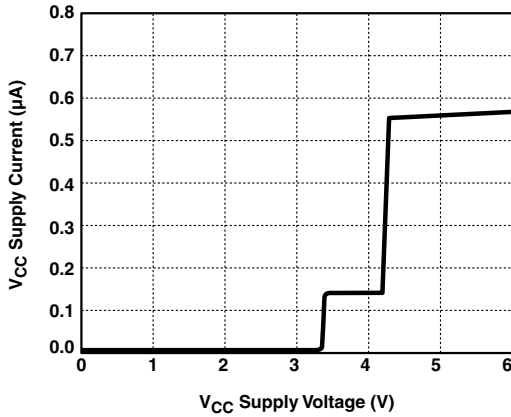

Figure 1. Supply Current vs Voltage ($V_{AUX} = 3.3V$)

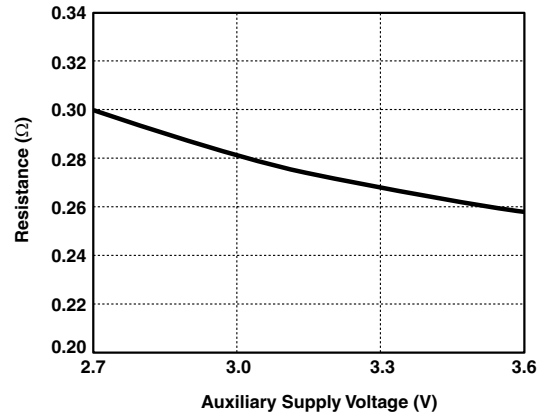

Figure 2. Switch Resistance vs Supply Voltage

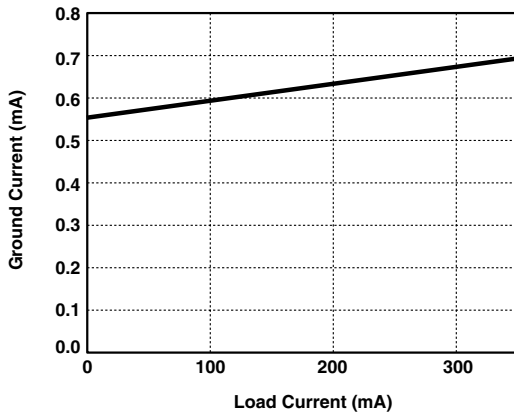

Figure 3. Ground Current vs Output Load

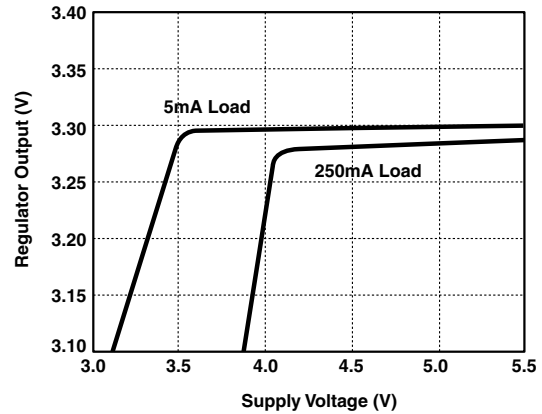

Figure 4. Line Regulation (1% and 100% rated load)

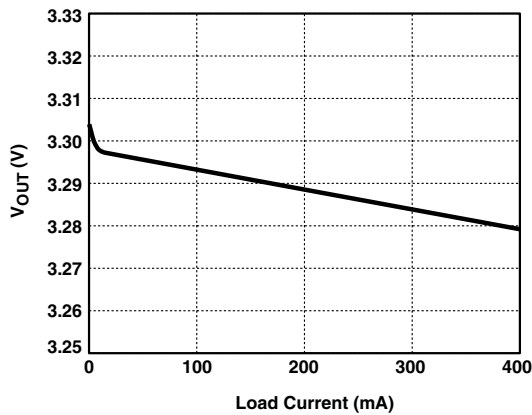

Figure 5. Load Regulation

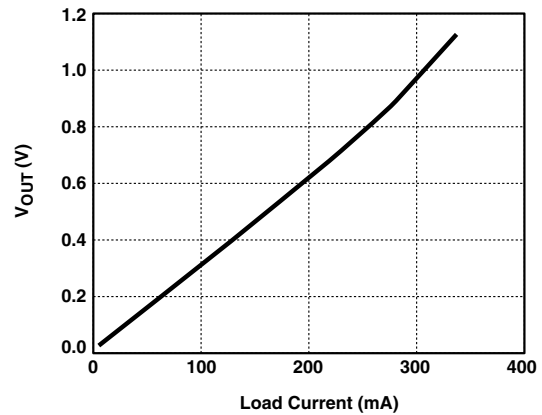

Figure 6. Dropout Voltage with Load Current

Performance Information (cont'd)

CMPWR101 Transient Characteristics (nominal conditions unless specified otherwise)
 (V_{CC} source resistance set to 0.2Ω)

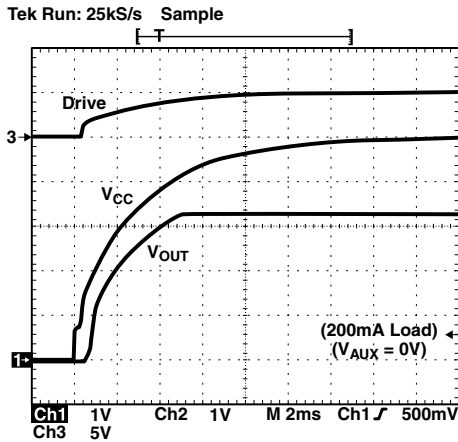

Figure 7. V_{CC} Cold start Power Up ($V_{AUX} = 0V$)

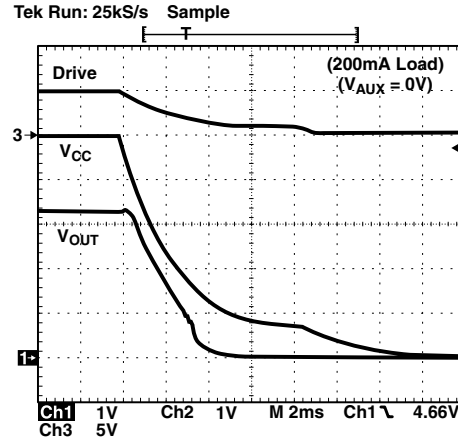

Figure 8. V_{CC} Complete Power Down ($V_{AUX} = 0V$)

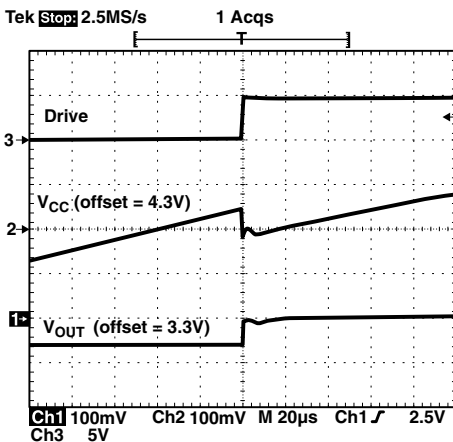

Figure 9. V_{CC} Power up ($V_{AUX} = 3.3V$)

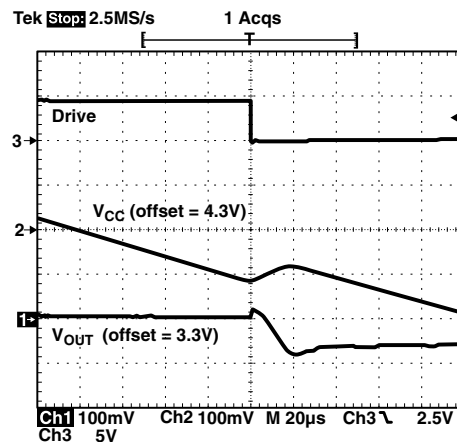

Figure 10. V_{CC} Power Down ($V_{AUX} = 3.3V$)

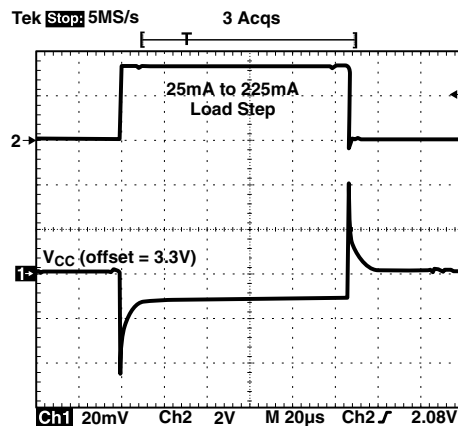

Figure 11. Load Transient (10% to 90%) Step Response

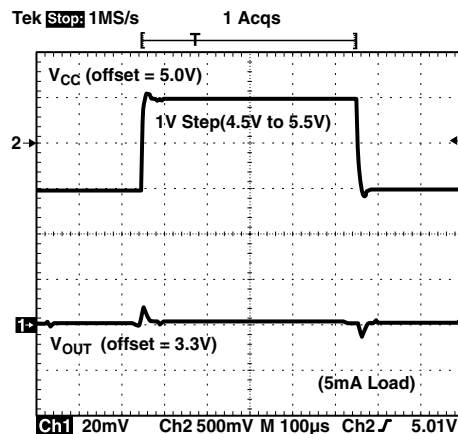

Figure 12. Line Transient (1Vpp) Step Response

Performance Information (cont'd)

CMPWR101 Typical Thermal Characteristics

The overall junction to ambient thermal resistance (θ_{JA}) for device power dissipation (P_D) consists primarily of two paths in series. The first path is the junction to the case (θ_{JC}) which is defined by the package style, and the second path is case to ambient (θ_{CA}) thermal resistance which is dependent on board layout. The final operating junction temperature for any set of conditions can be estimated by the following thermal equation:

$$\begin{aligned} T_{JUNC} &= T_{AMB} + P_D (\theta_{JC}) + P_D (\theta_{CA}) \\ &= T_{AMB} + P_D (\theta_{JA}) \end{aligned}$$

The CMPWR101 uses a standard SOIC package. When this package is mounted on a double-sided printed circuit board with two square inches of copper allocated for "heat spreading", the resulting θ_{JA} is 85°C/W.

Based on a maximum power dissipation of 0.43W (1.7V x 250mA) with an ambient of 70°C, the resulting junction temperature will be:

$$\begin{aligned} T_{JUNC} &= T_{AMB} + P_D (\theta_{JA}) \\ &= 70^\circ\text{C} + 0.43\text{W} (80^\circ\text{C/W}) \\ &= 70^\circ\text{C} + 37^\circ\text{C} = 103^\circ\text{C} \end{aligned}$$

Thermal characteristics were measured using a double-sided board with two square inches of copper area connected to the GND pin for "heat spreading".

Measurements showing performance up to junction temperature of 125°C were performed under light load conditions (5mA). This allows the ambient temperature to be representative of the internal junction temperature.

Note: The use of multi-layer board construction with separate ground and power planes will further enhance the overall thermal performance. In the event of no copper area being dedicated for heat spreading, a multi-layer board construction, using only the minimum size pad layout, will provide the CMPWR101 with an overall θ_{JA} of 100°C/W which allows up to 500mW to be safely dissipated.

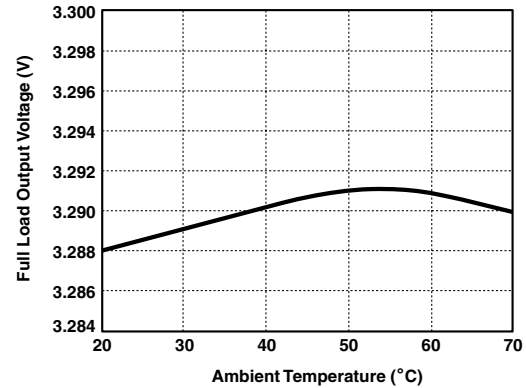

Figure 13. Regulator V_{OUT} vs T_{AMB} (250mA Load)

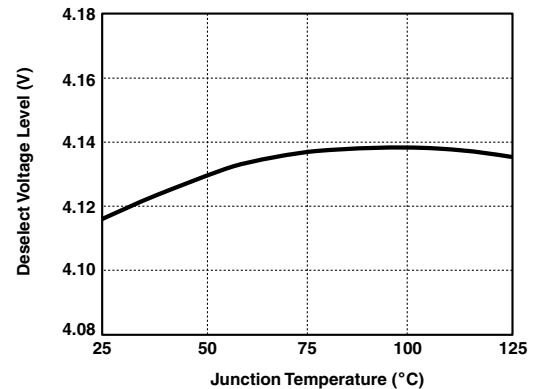

Figure 14. Deselect Threshold vs T_{JUNCT}

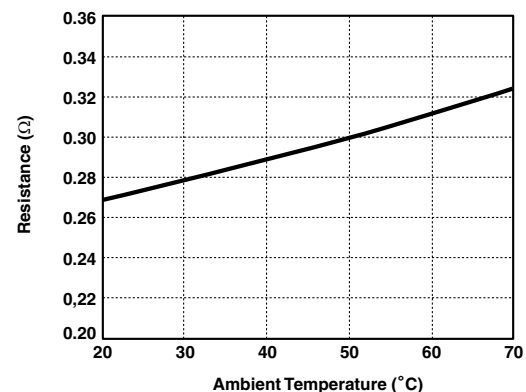

Figure 15. Switch Resistance vs Ambient Temperature

Mechanical Details

SOIC-8 Mechanical Specifications

Dimensions for CMPWR101 devices packaged in 8-pin SOIC packages are presented below.

For complete information on the SOIC-8 package, see the California Micro Devices SOIC Package Information document.

PACKAGE DIMENSIONS				
Package	SOIC			
Pins	8			
Dimensions	Millimeters		Inches	
	Min	Max	Min	Max
A	1.35	1.75	0.053	0.069
A₁	0.10	0.25	0.004	0.010
B	0.33	0.51	0.013	0.020
C	0.19	0.25	0.007	0.010
D	4.80	5.00	0.189	0.197
E	3.80	4.19	0.150	0.165
e	1.27 BSC		0.050 BSC	
H	5.80	6.20	0.228	0.244
L	0.40	1.27	0.016	0.050
# per tube	100 pieces*			
# per tape and reel	2500 pieces			
Controlling dimension: inches				

* This is an approximate number which may vary.

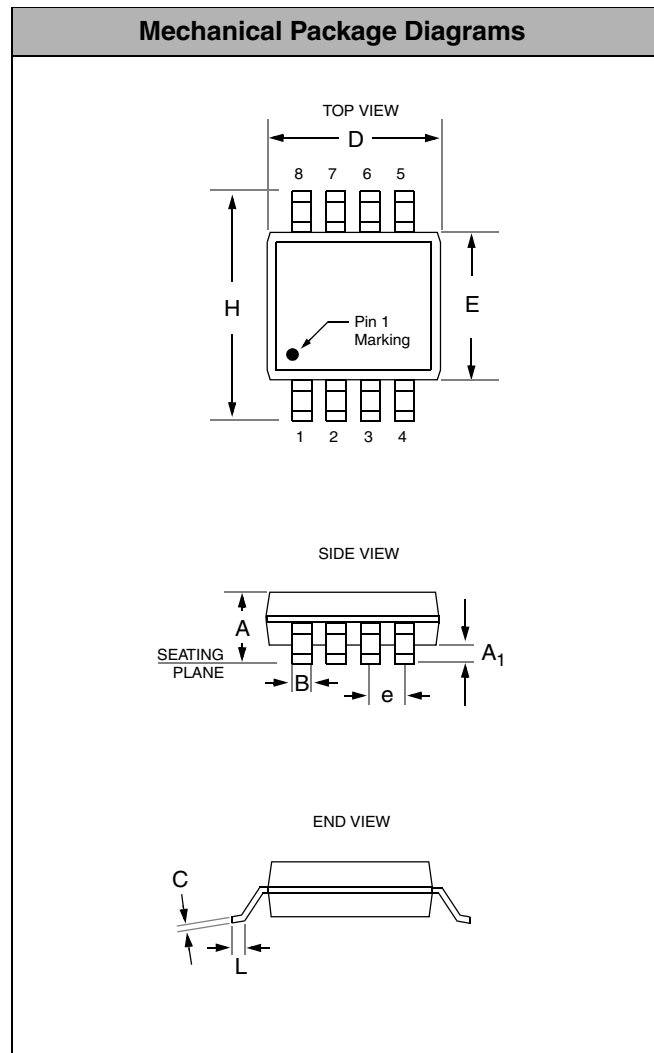

Package Dimensions for SOIC-8